

# MS5534C (RoHS) 型压力传感器

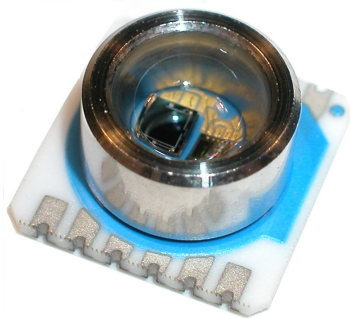

- 10 ~ 1100 mbar 绝压量程
- 芯片拥有6个软件补偿温度系数
- 硅压阻式压力芯片
- 安装尺寸9 × 9mm
- 16Bit ADC
- 3线接口
- 1个系统周期线(32.768KHz)
- 低电压，低功耗
- RoHS认证&无铅

## 产品说明

MS5534C型硅压阻式压力传感器采用先进的ADC模数转换IC电路，可提供16位的压力和温度数字输出。同时，该传感器拥有6级高精度软件校正系数。MS5534C主要特点是低压、低功耗及带功耗自动可调开关。三线制输出可方便与所有控制器连接。

MS5534C与MS5534A和MS5534B在软件上完全兼容，但在ESD灵敏度上已经改进到4KV。

## 特点

- 高精度
- 供电电压：2.2V ~ 3.6V
- 供电电流低
- -40 ~ +125 工作温度

## 应用

- 移动高度计/气压计系统
- 天气控制系统
- 手表
- GPS接收器

## 电路图



图1：MS5534C电路图

# MS5534C (RoHS) 型压力传感器

## 电气连接

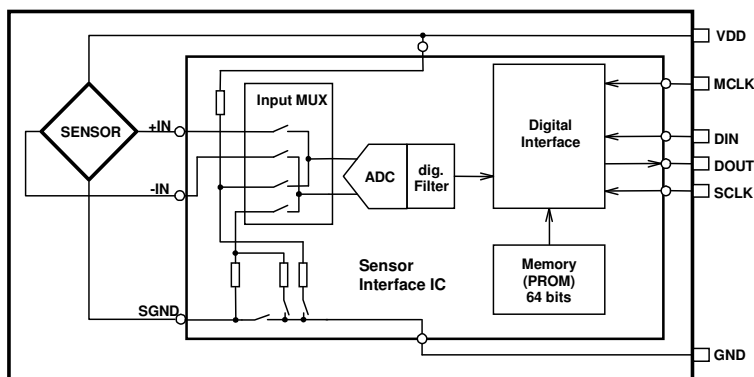

图2：MS5534C电气连接图

引脚名称	引脚	类型	功能
GND	1	G	接地
SCLK	2	I	系列数据时钟
DOUT	3	O	数据输出
DIN	4	I	数据输入
MCLK	5	I	主时钟(32.768 kHz)
VDD	6	P	供电正极
PEN (1)	7	I	程序设定
PV (1)	8	N	程序设定负极

注：

1. 引脚7(PEN)和引脚8(PV)为工厂校正用，不需要连接。

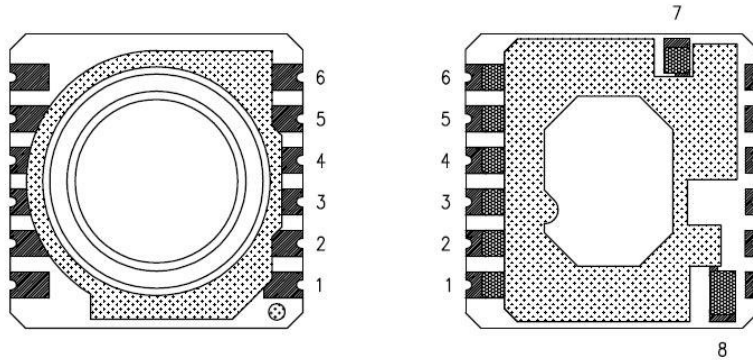
## 性能参数

参数	符号	条件	最小值	最大值	单位	备注
供电电压	VDD	Ta = 25 °C	-0.3	4	V	
储藏温度	T <sub>s</sub>		-40	+125	°C	1
过载压力	P	MS5534-CP, Ta = 25 °C		5	bar	
		MS5534-CM, Ta = 25 °C		10	bar	2

注：

1. 储存和工作在干燥的非腐蚀性气体中。
2. MS5534CM通过ISO2281认证，可经受11Bar的咸水压力或100m水压。

# MS5534C (RoHS) 型压力传感器

## 正常工作条件

(Ta = 25 °C, VDD = 3.0 V 除非特别注明)

参数	符号	条件	最小值	典型值	最大值	单位
压力量程	p		10		1100	mbar abs.
供电电压	VDD		2.2	3.0	3.6	V
供电电流 平均(1) 响应期(2) 稳定期(无变化)	$I_{avg}$ $I_{sc}$ $I_{ss}$	VDD = 3.0 V		4 1	0.1	$\mu$ A mA $\mu$ A
MCLK电流功耗(3)		MCLK = 32.768 kHz			0.5	$\mu$ A
工作温度范围	T		-40		+125	°C
响应时间	$t_{conv}$	MCLK = 32.768 kHz			35	ms
外部时钟信号(4)	MCLK		30.000	32.768	35.000	kHz
MCLK占空比			40/60	50/50	60/40	%
串口时钟	SCLK				500	kHz

注：

1. 假设每秒转换一次。该转换指MS5534C串行接口命令开始一次压力或温度测量。
2. 转换时传感器将打开或关闭以便节约功耗。一次转换时间为2ms。
3. MS5534C在待机模式下关闭MCLK可以减少功耗。
4. 由于该传感器对时基抖动非常灵敏，强力推荐使用晶体振荡器。

# MS5534C (RoHS) 型压力传感器

## 正常工作条件

### 数字输入

(T = -40°C .. 125°C, VDD = 2.2 V .. 3.6 V)

参数	符号	条件	最小值	典型值	最大值	单位
输入高电压	V <sub>IH</sub>		80% VDD		100% VDD	V
输入低电压	V <sub>IL</sub>		0% VDD		20% VDD	V
信号上升时间	t <sub>r</sub>			200		ns
信号下降时间	t <sub>f</sub>			200		ns

### 数字输出

(T = -40°C .. 125°C, VDD = 2.2 V .. 3.6 V)

参数	符号	条件	最小值	典型值	最大值	单位
输出高电压	V <sub>OH</sub>	I <sub>source</sub> = 0.6 mA	80% VDD		100% VDD	V
输出低电压	V <sub>OL</sub>	I <sub>sink</sub> = 0.6 mA	0% VDD		20% VDD	V
信号上升时间	t <sub>r</sub>			200		ns
信号下降时间	t <sub>f</sub>			200		ns

### AD转换

(T = -40°C .. 125°C, VDD = 2.2 V .. 3.6 V)

参数	符号	条件	最小值	典型值	最大值	单位
分辨率				16		Bit
线性范围			4000		40000	LSB
转换时间		MCLK = 32.768 kHz			35	ms
INL		在线性范围内	-5		+5	LSB

# MS5534C (RoHS) 型压力传感器

## 输出参数

下列参数在MS5534C的IC中存有校正数据下测得。

(VDD = 3.0 V 除非另有说明)

参数	条件	最小值	典型值	最大值	单位	备注
分辨率			0.1		mbar	1
绝压压力精度	p = 750 .. 1100 mbar T <sub>a</sub> = 25°C	-1.5		+1.5	mbar	2
相对压力精度	p = 750 .. 1100 mbar T <sub>a</sub> = 25°C	-0.5		+0.5	mbar	3
相对压力误差	T = 0 .. +85°C p = 300 .. 1000 mbar	-2		+2	mbar	4
	T = -40 .. +125°C p = 300 .. 1000 mbar	-8		+5	mbar	4
长期稳定性	12 months		-1		mbar	5
最大误差	VDD = 2.2 .. 3.6 V p = const.	-1.6		+1.6	mbar	

注：

1. 由于ADC转换存在噪音，在读取稳定的压力分辨率时需要采用2到4个压力数据。
2. 在压力量程内最大压力误差。
3. 在某个点校正后压力量程内最大压力误差。
4. 二级温度补偿，详情见下页典型工作曲线。
5. 长期稳定性测量在无焊接设备下。

## 温度输出参数

该温度输出参主要用于有温度补偿的情况下。

(VDD = 3.0 V 除非另有说明)

参数	条件	最小值	典型值	最大值	单位	备注
分辨率		0.005	0.01	0.015	°C	
精度	T = 20°C	-0.8		0.8	°C	
	T = -20 .. +85°C	-2		+2	°C	1
	T = -40 .. +125°C	-6		+3	°C	1
最大误差	VDD = 2.2 .. 3.6 V	-0.2		+0.2	°C	2

注：

1. 二级温度补偿，详情见下页典型工作曲线。
2. T<sub>a</sub> = 25 °C。

# MS5534C (RoHS) 型压力传感器

## 典型性能曲线

ADC-value D1 vs Pressure (typical)

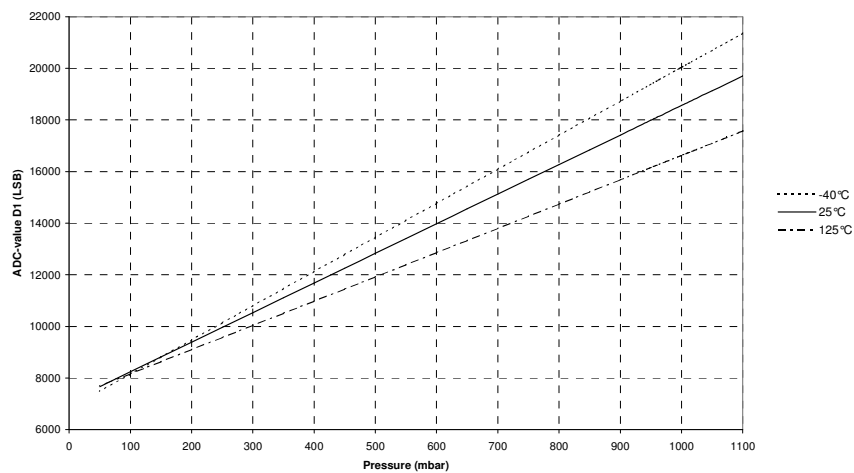

ADC-value D2 vs Temperature (typical)

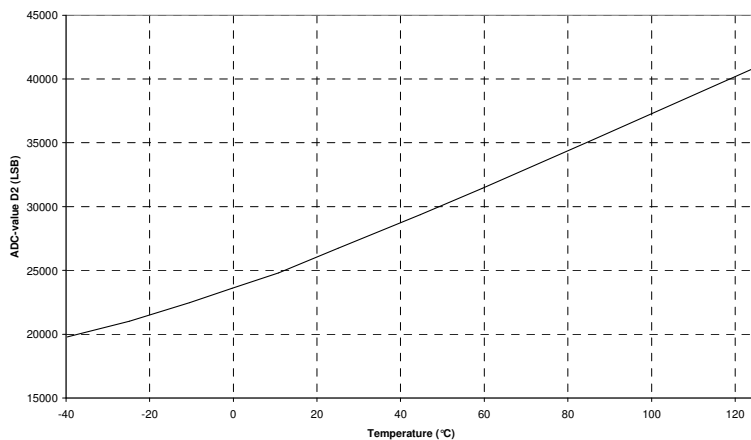

Absolute Pressure Accuracy after Calibration, 2nd order compensation

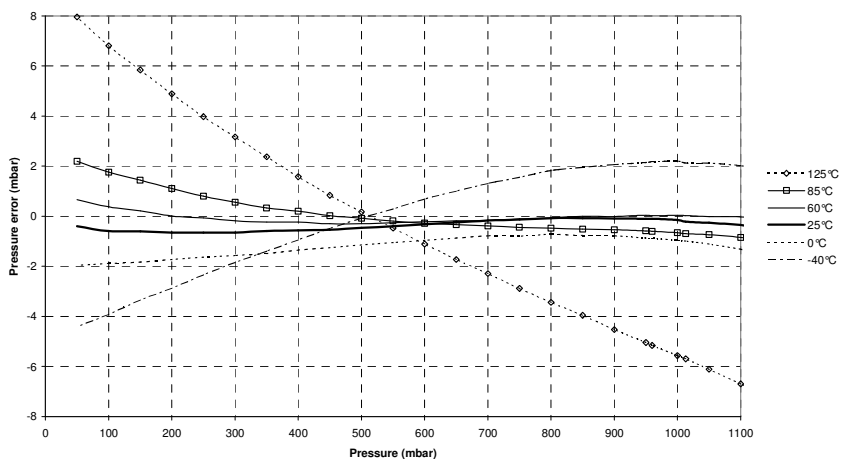

# MS5534C (RoHS) 型压力传感器

Temperature Error Accuracy vs temperature (typical)

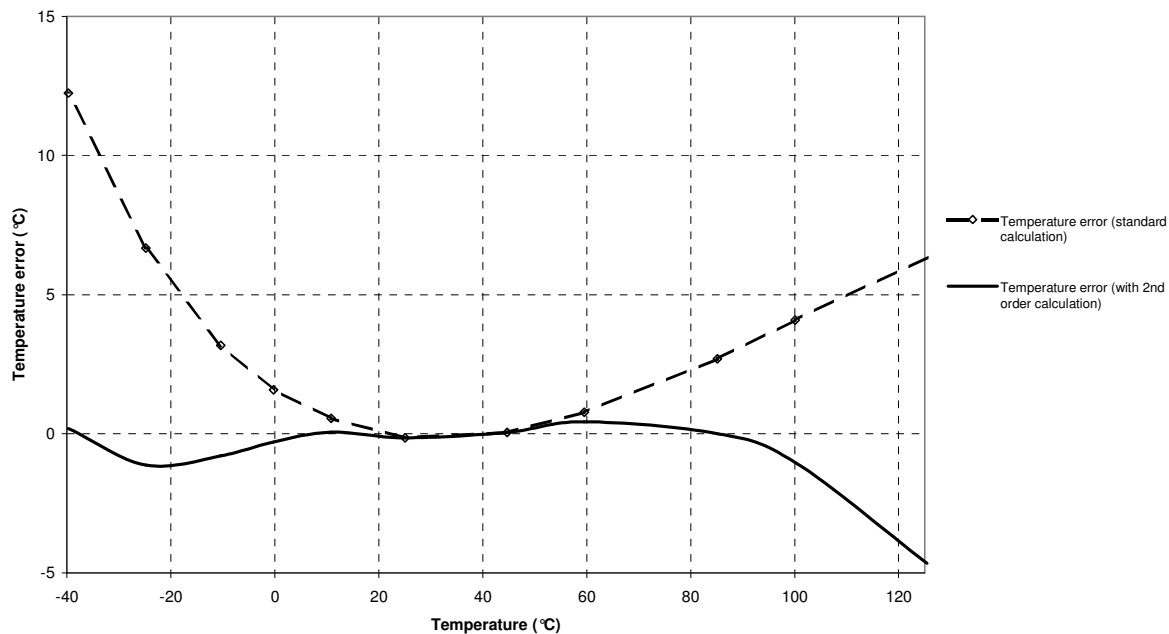

Pressure Error Accuracy vs temperature (typical)

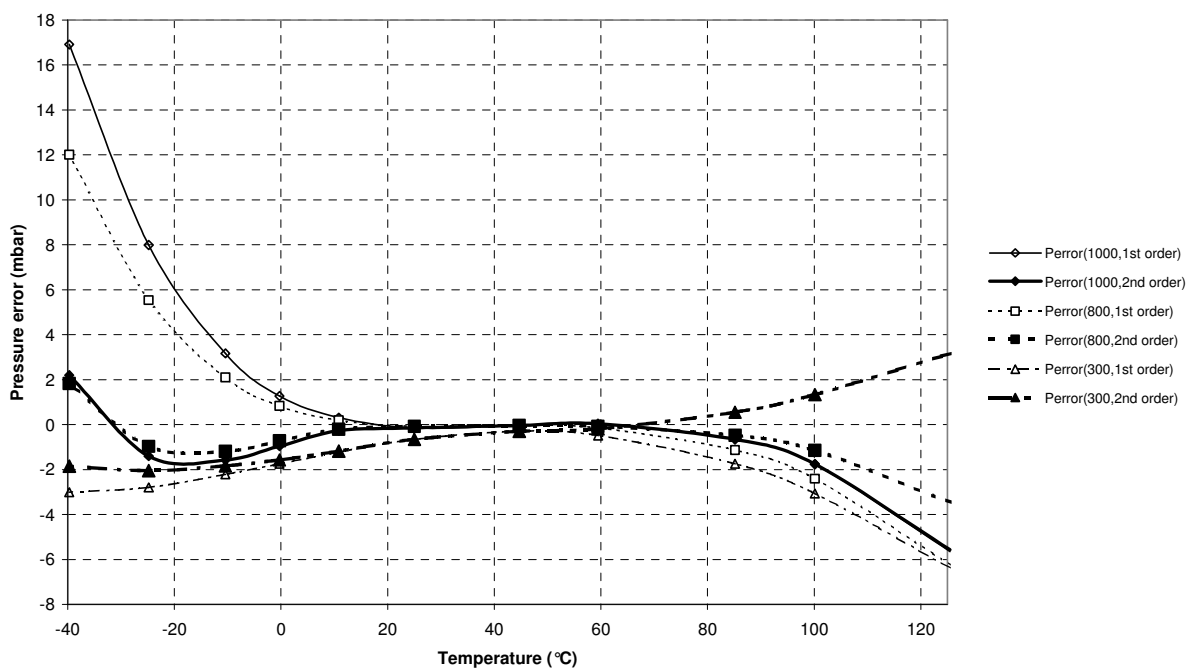

# MS5534C (RoHS) 型压力传感器

Pressure error vs supply voltage (typical)

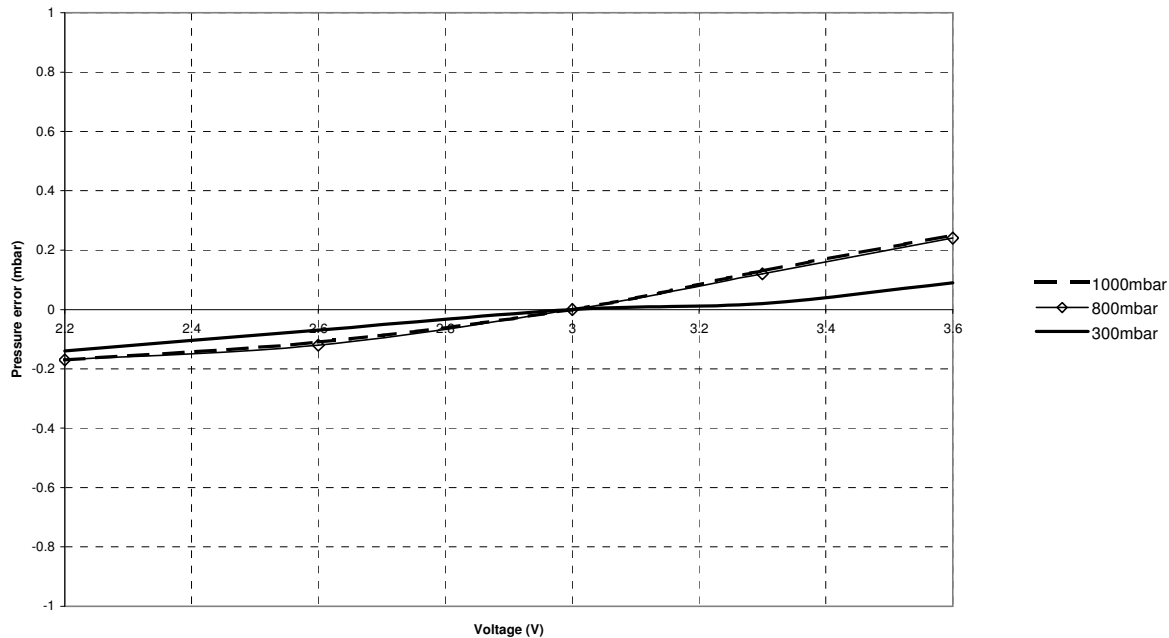

Temperature error vs supply voltage (typical)

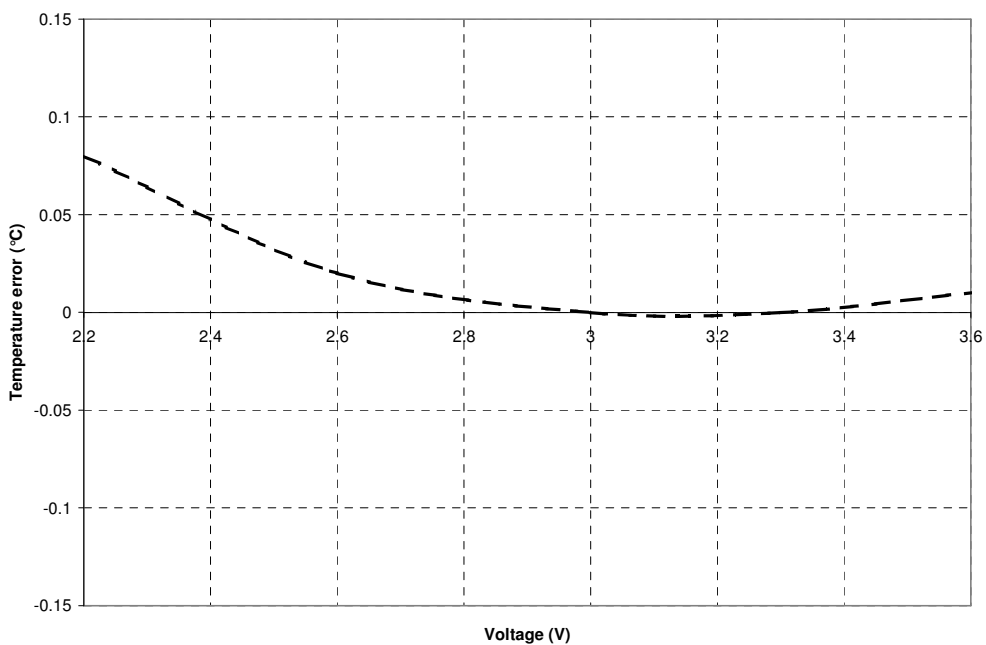



# MS5534C (RoHS) 型压力传感器

## FUNCTION

### GENERAL

The MS5534C consists of a piezoresistive sensor and a sensor interface IC. The main function of the MS5534C is to convert the uncompensated analogue output voltage from the piezoresistive pressure sensor to a 16-Bit digital value, as well as providing a 16-Bit digital value for the temperature of the sensor.

- measured pressure (16-Bit) "D1"
- measured temperature (16-Bit) "D2"

As the output voltage of a pressure sensor is strongly dependent on temperature and process tolerances, it is necessary to compensate for these effects. This compensation procedure must be performed by software using an external microcontroller.

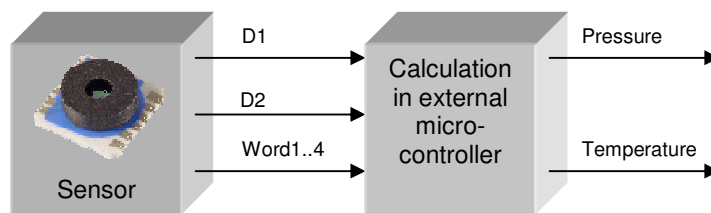

For both pressure and temperature measurement the same ADC is used (sigma delta converter):

- for the pressure measurement, the differential output voltage from the pressure sensor is converted
- for the temperature measurement, the sensor bridge resistor is sensed and converted

During both measurements the sensor will only be switched on for a very short time in order to reduce power consumption. As both, the bridge bias and the reference voltage for the ADC are derived from VDD, the digital output data is independent of the supply voltage.

### FACTORY CALIBRATION

Every module is individually factory calibrated at two temperatures and two pressures. As a result, 6 coefficients necessary to compensate for process variations and temperature variations are calculated and stored in the 64-Bit PROM of each module. These 64-Bit (partitioned into four words of 16-Bit) must be read by the microcontroller software and used in the program converting D1 and D2 into compensated pressure and temperature values.

### PRESSURE AND TEMPERATURE MEASUREMENT

The sequence of reading pressure and temperature as well as of performing the software compensation is depicted in Fig. 3 and Fig. 5.

First the Word1 to Word4 have to be read through the serial interface. This can be done once after reset of the microcontroller that interfaces to the MS5534C. Next the compensation coefficients C1 to C6 are extracted using Bit-wise logical- and shift-operations (refer to Fig. 4 for the Bit-pattern of Word1 to Word4).

For the pressure measurement the microcontroller has to read the 16 Bit values for pressure (D1) and temperature (D2) via the serial interface in a loop (for instance every second). Then, the compensated pressure is calculated out of D1, D2 and C1 to C6 according to the algorithm in Fig. 3 (possibly using quadratic temperature compensation according to Fig. 5). All calculations can be performed with signed 16-Bit variables. Results of multiplications may be up to 32-Bit long (+sign). In the flow according to Fig. 3 each multiplication is followed by a division. This division can be performed by Bit-wise shifting (divisors are to the power of 2). It is ensured that the results of these divisions are less than 65536 (16-Bit).

For the timing of signals to read out Word1 to Word4, D1, and D2 please refer to the paragraph "Serial Interface".

# MS5534C (RoHS) 型压力传感器

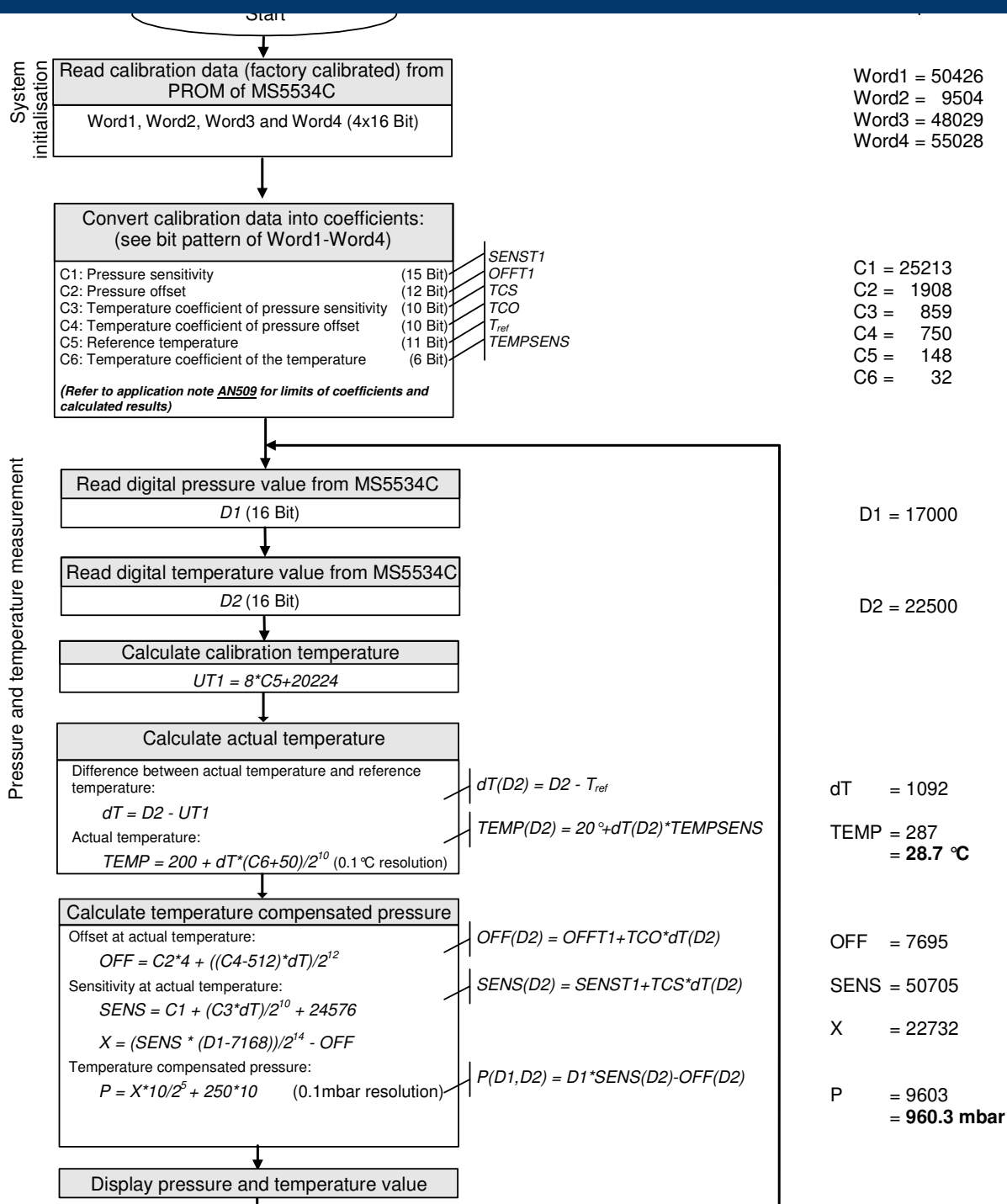

Fig. 3: Flow chart for pressure and temperature reading and software compensation.

## NOTES

- 1) Readings of D2 can be done less frequently, but the display will be less stable in this case.
- 2) For a stable display of 0.1 mbar resolution, it is recommended to display the average of 8 subsequent pressure values.

# MS5534C (RoHS) 型压力传感器

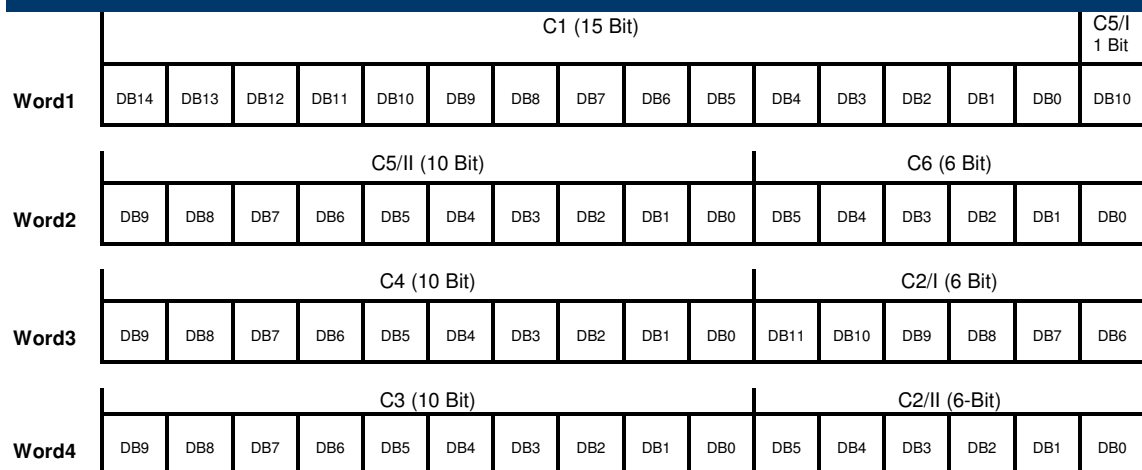

Fig. 4: Arrangement (Bit-pattern) of calibration data in Word1 to Word4.

## SECOND-ORDER TEMPERATURE COMPENSATION

In order to obtain best accuracy over the whole temperature range, it is recommended to compensate for the non-linearity of the output of the temperature sensor. This can be achieved by correcting the calculated temperature and pressure by a second order correction factor. The second-order factors are calculated as follows:

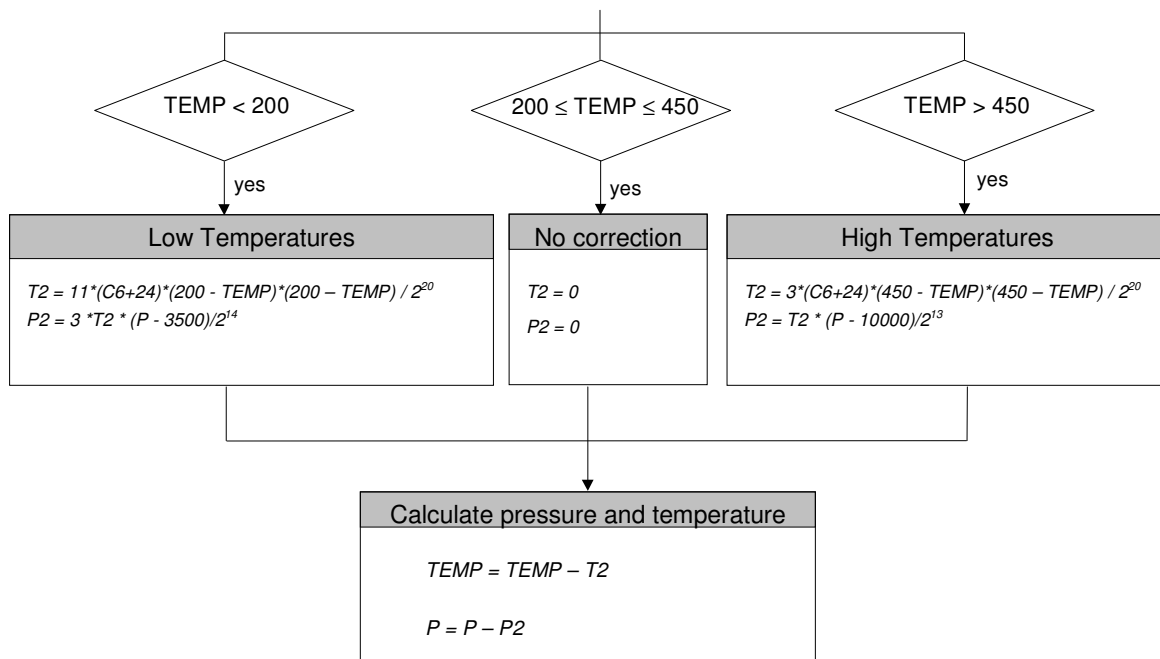

Fig. 5: Flow chart for calculating the temperature and pressure to the optimum accuracy.

# MS5534C (RoHS) 型压力传感器

The MS5534C communicates with microprocessors and other digital systems via a 3-wire synchronous serial interface as shown in Fig. 1. The SCLK (Serial clock) signal initiates the communication and synchronises the data transfer with each Bit being sampled by the MS5534C on the rising edge of SCLK and each Bit being sent by the MS5534C on the rising edge of SCLK. The data should thus be sampled by the microcontroller on the falling edge of SCLK and sent to the MS5534C with the falling edge of SCLK. The SCLK-signal is generated by the microprocessor's system. The digital data provided by the MS5534C on the DOUT pin is either the conversion result or the software calibration data. In addition the signal DOUT (Data output) is also used to indicate the conversion status (conversion-ready signal, see below). The selection of the output data is done by sending the corresponding instruction on the pin DIN (Data input).

Following is a list of possible output data instructions:

- Conversion start for pressure measurement and ADC-data-out "D1" (Figure 6a)
- Conversion start for temperature measurement and ADC-data-out "D2" (Figure 6b)
- Calibration data read-out sequence for Word1 (Figure 6c)
- Calibration data read-out sequence for Word2 (Figure 6d)
- Calibration data read-out sequence for Word3 (Figure 6c)
- Calibration data read-out sequence for Word4 (Figure 6d)
- RESET sequence (Figure 6e)

Every communication starts with an instruction sequence at pin DIN. Fig. 6 shows the timing diagrams for the MS5534C. The device does not need a 'Chip select' signal. Instead there is a START sequence (3-Bit high) before each SETUP sequence and STOP sequence (3-Bit low) after each SETUP sequence. The SETUP sequence consists in 4-Bit that select a reading of pressure, temperature or calibration data. In case of pressure- (D1) or temperature- (D2) reading the module acknowledges the start of a conversion by a low to high transition at pin DOUT.

Two additional clocks at SCLK are required after the acknowledge signal. Then SCLK is to be held low by the microcontroller until a high to low transition on DOUT indicates the end of the conversion.

This signal can be used to create an interrupt in the microcontroller. The microcontroller may now read out the 16-Bit word by giving another 17 clocks on the SCLK pin. It is possible to interrupt the data READOUT sequence with a hold of the SCLK signal. **It is important to always read out the last conversion result before starting a new conversion.**

The RESET sequence is special as its unique pattern is recognised by the module in any state. By consequence it can be used to restart if synchronisation between the microcontroller and the MS5534C has been lost. This sequence is 21-Bit long. The DOUT signal might change during that sequence (see Fig. 6e). It is recommended to send the RESET sequence before first CONVERSION sequence to avoid hanging up the protocol permanently in case of electrical interference.

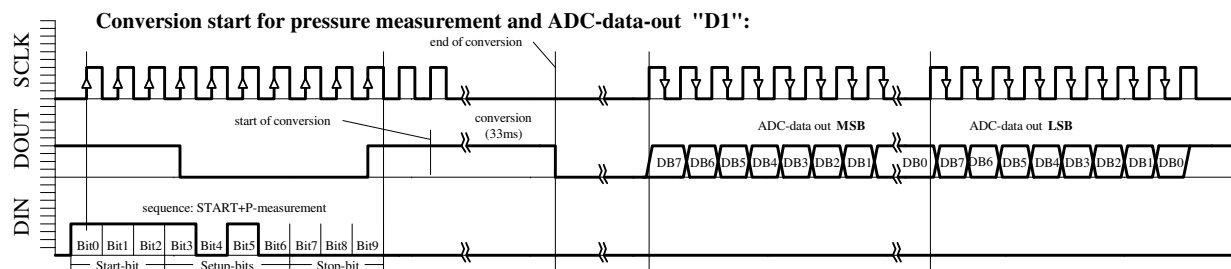

Fig. 6a: D1 ACQUISITION sequence.

# MS5534C (RoHS) 型压力传感器

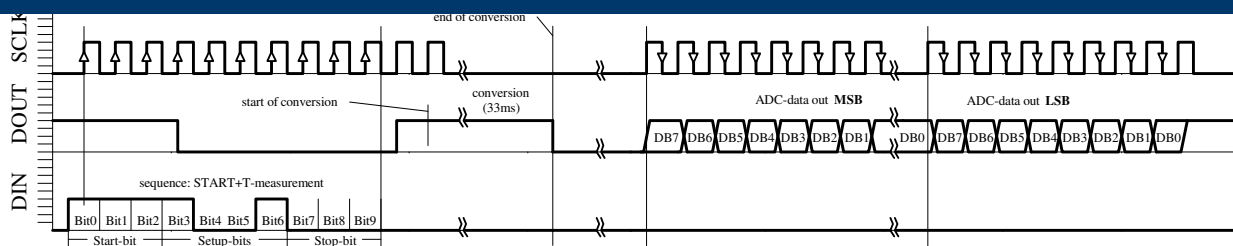

Fig. 6b: D2 ACQUISITION sequence.

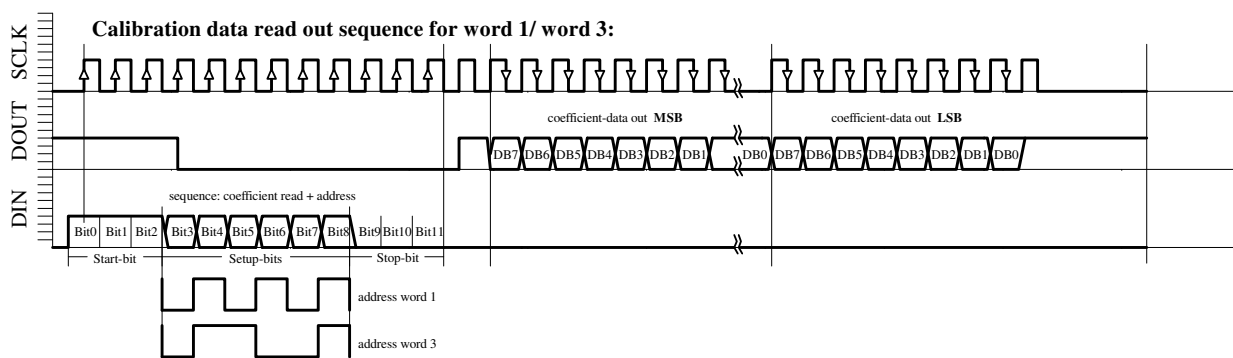

Fig. 6c: Word1, Word3 READING sequence.

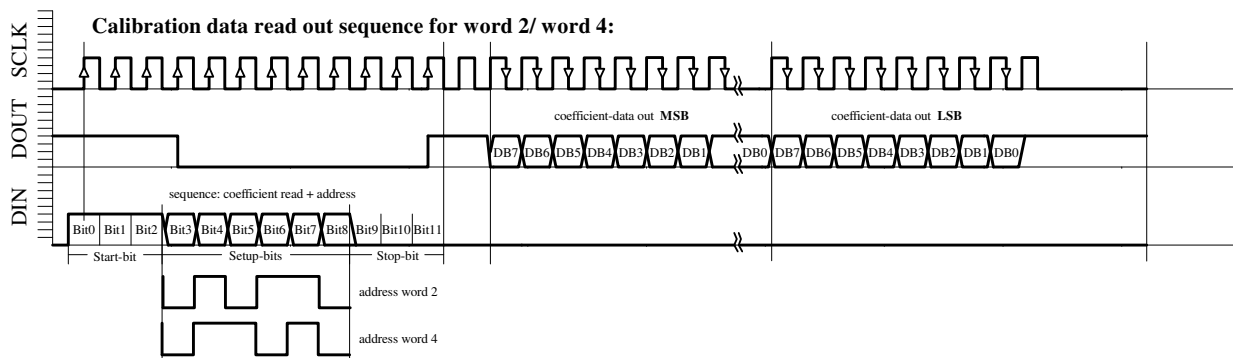

Fig. 6d: W2, W4 READING sequence.

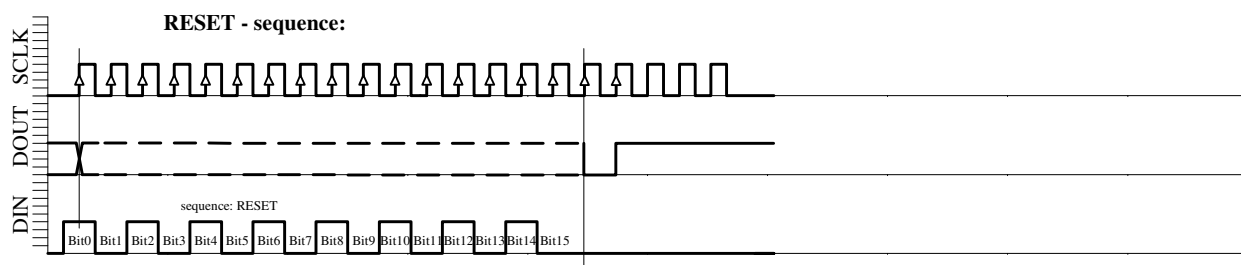

Fig. 6e: RESET sequence (21-Bit).

# MS5534C (RoHS) 型压力传感器

## APPLICATION INFORMATION

### GENERAL

The advantage of combining a pressure sensor with a directly adapted integrated circuit is to save other external components and to achieve very low power consumption. The main application field for this system includes portable devices with battery supply, but its high accuracy and resolution make it also suited for industrial and automotive applications. The possibility to compensate the sensor with software allows the user to adapt it to his particular application. Communication between the MS5534C and the widely available microcontrollers is realised over an easy-to-use 3-wire serial interface. Customers may select which microcontroller system to be used, and there are no specific standard interface cells required, which may be of interest for specially designed 4 Bit-microcontroller applications.

### CALIBRATION

The MS5534C is factory calibrated. The calibration data is stored inside the 64-Bit PROM memory.

### SOLDERING

Please refer to the application note AN808 for all soldering issues.

### HUMIDITY, WATER PROTECTION

The version MS5534CM carries a metal protection cap filled with silicone gel for enhanced protection against humidity. The properties of this gel ensure function of the sensor even when in direct water contact. This feature can be useful for waterproof watches or other applications, where direct water contact cannot be avoided. Nevertheless the user should avoid drying of hard materials like for example salt particles on the silicone gel surface. In this case it is better to rinse with clean water afterwards. Special care has to be taken to not mechanically damage the gel. Damaged gel could lead to air entrapment and consequently to unstable sensor signal, especially if the damage is close to the sensor surface.

The metal protection cap is fabricated of special anticorrosive stainless steel in order to avoid any corrosive battery effects inside the final product. The MS5534CM was qualified referring to the ISO Standard 2281 and can withstand a pressure of 11 bar in salt water. The concentration of the sea water used for the qualification is 41 g of sea salt for 1 litre of DI water.

For underwater operations as specified in ISO Standard 2281 it is important to seal the sensor with a rubber O-ring around the metal cap. Any salt water coming to the contact side (ceramic and pads) of the sensor could lead to permanent damage. Especially for "water-resistant 100 m" watches it is recommended to provide a stable mechanical pusher from the backside of the sensor. Otherwise the overpressure might push the sensor backwards and even bend the electronic board on which the sensor is mounted.

### LIGHT SENSITIVITY

The MS5534C is sensitive to sunlight, especially to infrared light sources. This is due to the strong photo effect of silicon. As the effect is reversible there will be no damage, but the user has to take care that in the final product the sensor cannot be exposed to direct light during operation. This can be achieved for instance by placing mechanical parts with holes in such that light cannot pass.

### CONNECTION TO PCB

The package outline of the module allows the use of a flexible PCB to connect it. This can be important for applications in watches and other special devices, and will also reduce mechanical stress on the device. For applications subjected to mechanical shock, it is recommended to enhance the mechanical reliability of the solder junctions by covering the rim or the corners of MS5534C's ceramic substrate with glue or Globtop-like material.

## MS5534C (RoHS) 型压力传感器

Particular care must be taken when connecting the device to power supply. A 47  $\mu\text{F}$  tantalum capacitor **must** be placed as close as possible of the MS5534C's VDD pin. This capacitor will stabilise the power supply during data conversion and thus, provide the highest possible accuracy.

### APPLICATION EXAMPLE: ALTIMETER SYSTEM USING MS5534C

MS5534C is a circuit that can be used in connection with a microcontroller in mobile altimeter applications. It is designed for low-voltage systems with a supply voltage of 3 V, particularly in battery applications. The MS5534C is optimised for low current consumption as the AD-converter clock (MCLK) can use the 32.768 kHz frequency of a standard watch crystal, which is supplied in most portable watch systems.

For applications in altimeter systems Intersema can deliver a simple formula to calculate the altitude, based on a linear interpolation, where the number of interpolation points influences the accuracy of the formula.

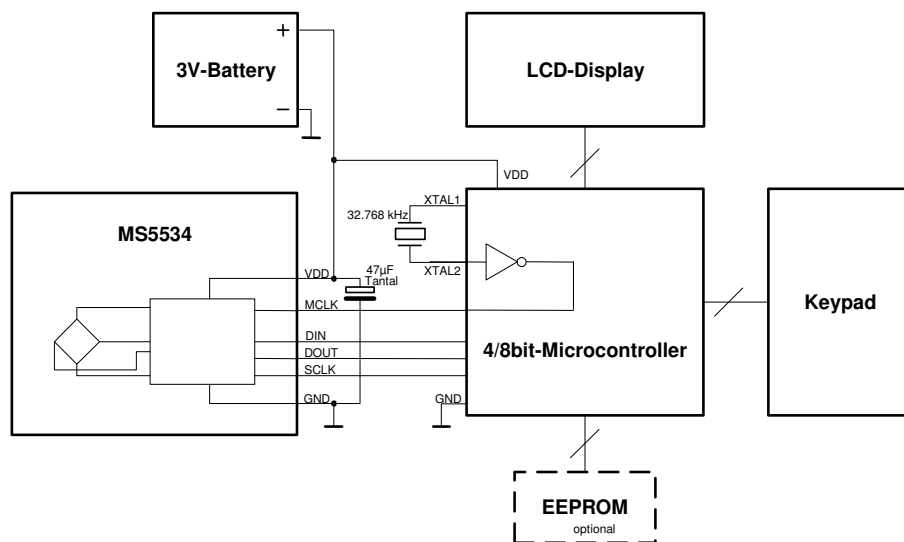

Figure 7: Demonstration of MS5534C in a mobile altimeter.

# MS5534C (RoHS) 型压力传感器

## DEVICE PACKAGE OUTLINES

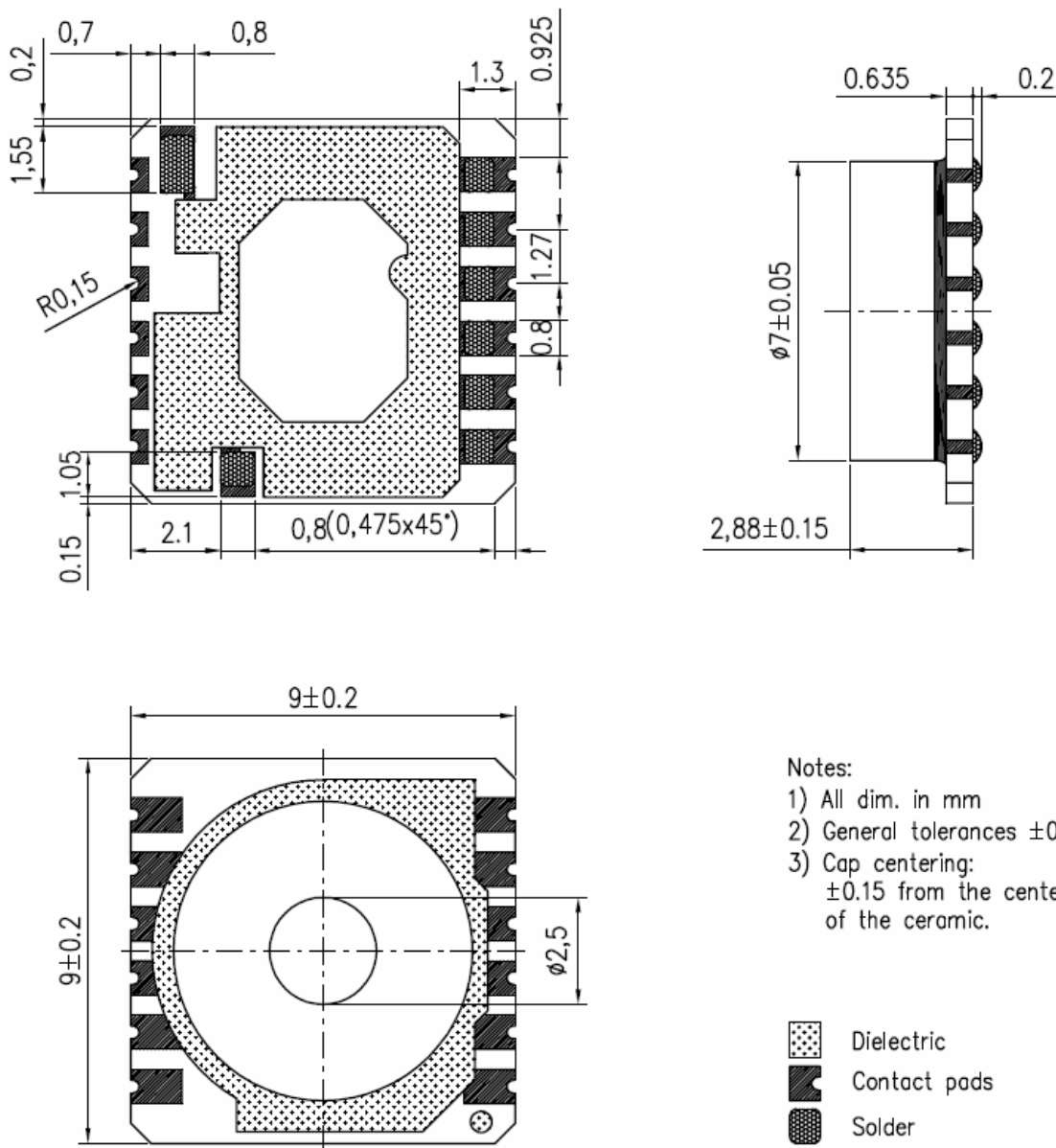
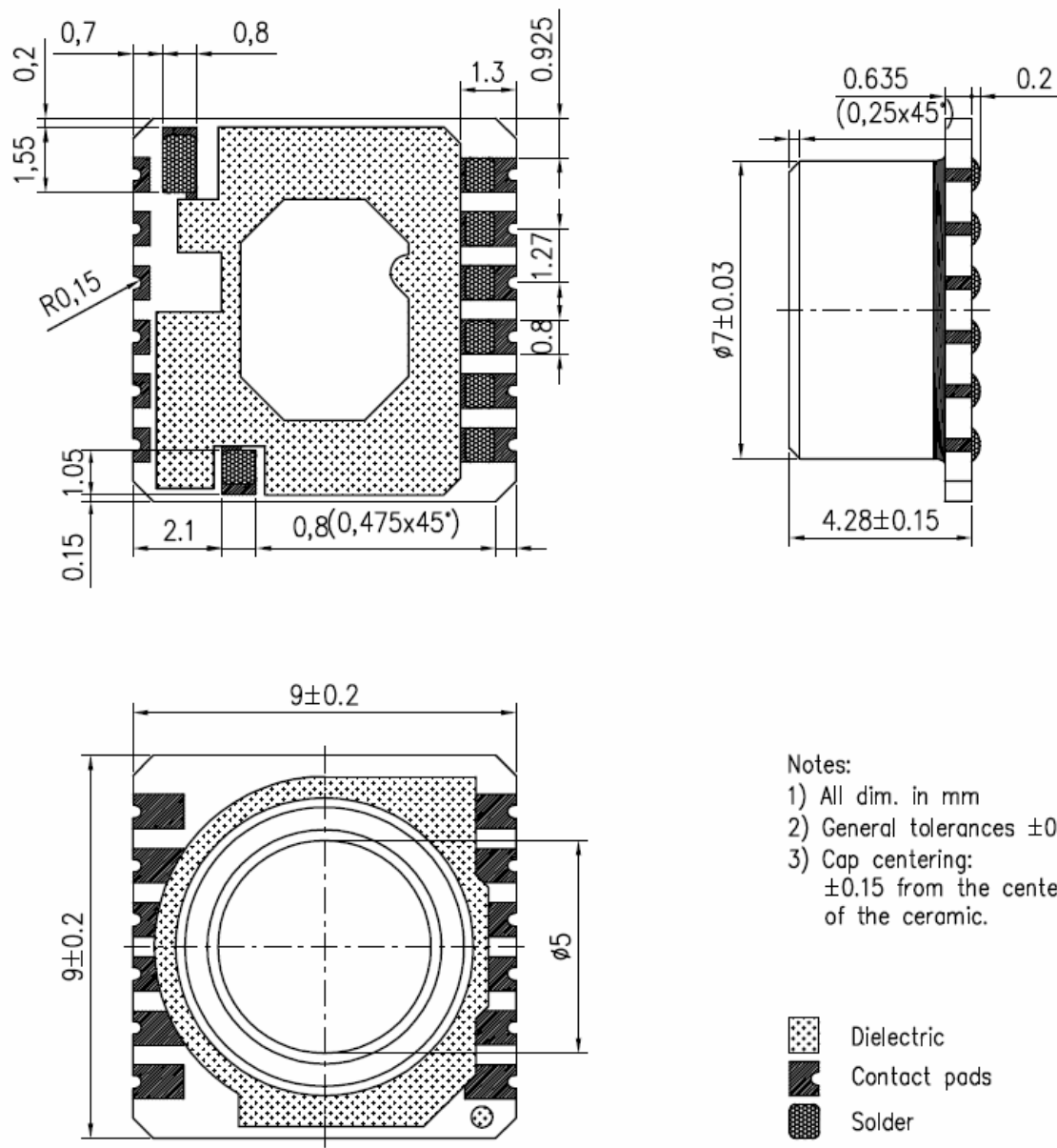

Fig. 8: Device package outlines of MS5534CP.



# MS5534C (RoHS) 型压力传感器

## DEVICE PACKAGE OUTLINES



- Notes:
- 1) All dim. in mm
  - 2) General tolerances  $\pm 0.1$
  - 3) Cap centering:  $\pm 0.15$  from the center of the ceramic.

Fig. 9: Device package outlines of MS5534CM.

# MS5534C (RoHS) 型压力传感器

## RECOMMENDED PAD LAYOUT

Pad layout for bottom side of MS5534C soldered onto printed circuit board

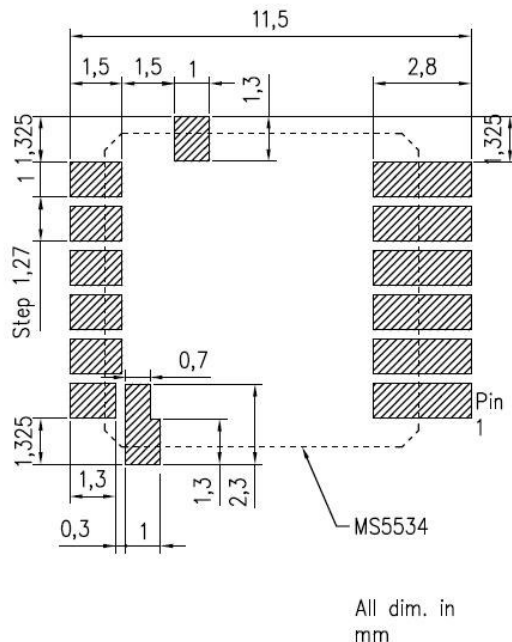

Fig. 10: Layout for bottom side

Pad layout for top side of MS5534C soldered onto printed circuit board

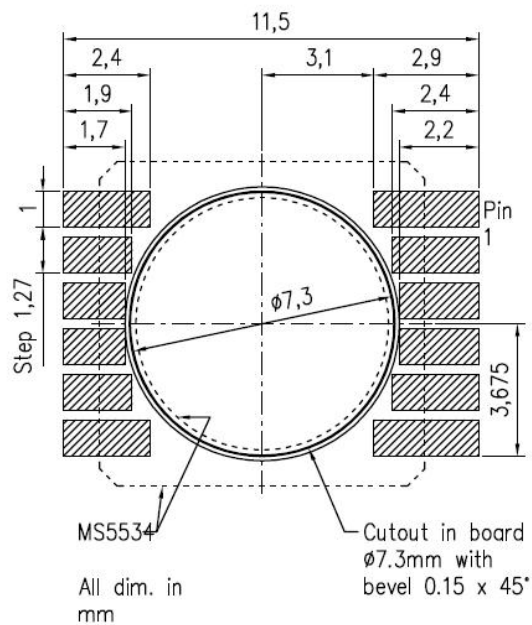

Fig. 11: Layout for top side

# MS5534C (RoHS) 型压力传感器

## ASSEMBLY

### MECHANICAL STRESS

It is recommended to avoid mechanical stress on the PCB on which the sensor is mounted. The thickness of the PCB should not be below 1.6 mm. A thicker PCB is stiffer creating less stress on the soldering contacts. For applications where mechanical stress cannot be avoided (for example ultrasound welding of the case or thin PCB's in watches) please fix the sensor with drops of low stress epoxy (for example Hysol FP-4401) at the corners of the sensor as shown below.

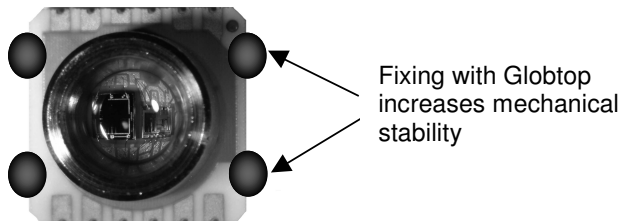

### MOUNTING

The MS5534C can be placed with automatic Pick&Place equipment using vacuum nozzles. It will not be damaged by the vacuum. Due to the low stress assembly the sensor does not show pressure hysteresis effects. Special care has to be taken to not touch the protective gel of the sensor during the assembly.

The MS5534C can be mounted with the cap down or the cap looking upwards. In both cases it is important to solder all contact pads. The Pins PEN and PV shall be left open or connected to VDD. **Do not connect the Pins PEN and PV to GND!**

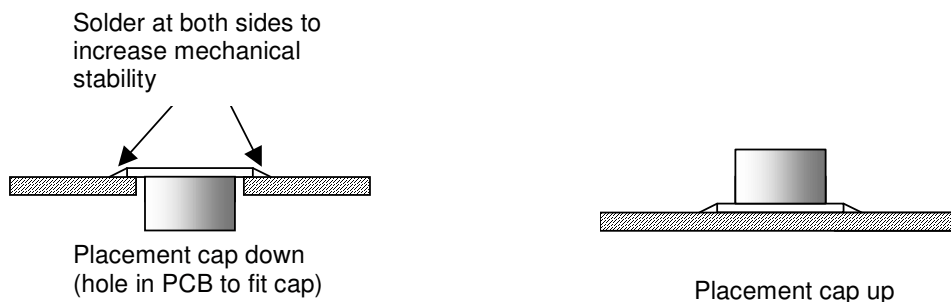

### SEALING WITH O-RING

In products like outdoor watches the electronics must be protected against direct water or humidity. For those products the MS5534CM provides the possibility to seal with an O-ring. The protective cap of the MS5534CM is made of special anticorrosive stainless steel with a polished surface. In addition to this the MS5534CM is filled with silicone gel covering the sensor and the bonding wires. The O-ring (or O-rings) shall be placed at the outer diameter of the metal cap. This method avoids mechanical stress because the sensor can move in vertical direction.

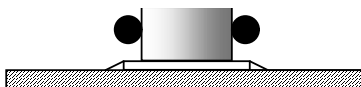

## MS5534C (RoHS) 型压力传感器

The MS5534C has been manufactured under cleanroom conditions. Each device has been inspected for the homogeneity and the cleanness of the silicone gel. It is therefore recommended to assemble the sensor under class 10'000 or better conditions. Should this not be possible, it is recommended to protect the sensor opening during assembly from entering particles and dust. To avoid cleaning of the PCB, solder paste of type "no-clean" shall be used. **Cleaning might damage the sensor!**

### ESD PRECAUTIONS

The electrical contact pads are protected against ESD up to 4 kV HBM (human body model). It is therefore essential to ground machines and personal properly during assembly and handling of the device. The MS5534C is shipped in antistatic transport boxes. Any test adapters or production transport boxes used during the assembly of the sensor shall be of an equivalent antistatic material.

## MS5534C (RoHS) 型压力传感器

---

### ORDERING INFORMATION

---

Product Code	Product	Art.-Nr.	Package	Comments
MS5534-CP	Barometer Module with plastic cap	325534008	SMD hybrid with solder paste, plastic protection cap	Standard version
MS5534-CM	Barometer Module with metal cap	325534009	SMD hybrid with solder paste, metal protection cap, silicon gel sensor protection	Recommended for outdoor products

---